

# Altagamma

Design by Dario Covi

Famiglia di contenitori e cassettiere, con ante e vani a giorno, tutti lavorato a 45°.  
Alcuni modelli possono essere accessoriati di vani passacavi.



## DESCRIZIONE TECNICA



### Struttura esterna / ante e frontali

Realizzati con pannelli di particelle e disponibili in finitura: Essenza, Ecopelle Time, Pelle Soft.

### Struttura interna

Realizzata con pannelli di particelle disponibili in finitura: Laccato sablè, Essenza.

### Maniglia

Maniglia dei mobili contenitori realizzata in acciaio spazzolato. Per le cassettiere sono disponibili maniglie a gola.

### Ripiani

Ripiani interni realizzati in vetro trasparente.



I mobili contenitori con ante e cassetti sono disponibili con finitura interamente in Essenza (struttura, ante, interni), maniglia in acciaio spazzolato e ripiani in vetro.

## DIMENSIONI

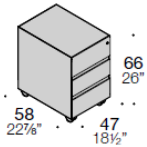

Cassettiera su ruote a 3 cassetti

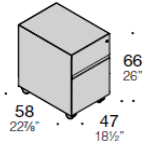

Cassettiera su ruote con cassetto e cassettone

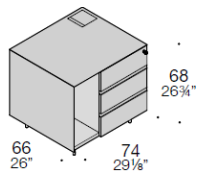

Mobile di servizio L74

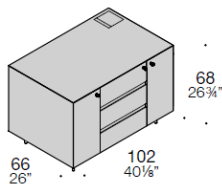

Mobile di servizio L102

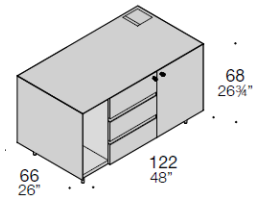

Mobile di servizio L122

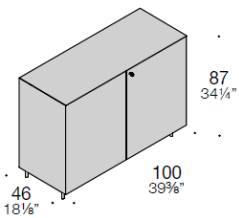

Contenitore L100

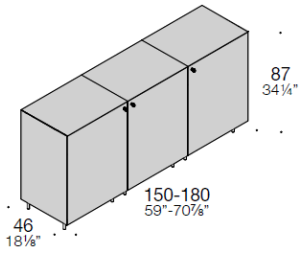

Contenitore L150-180

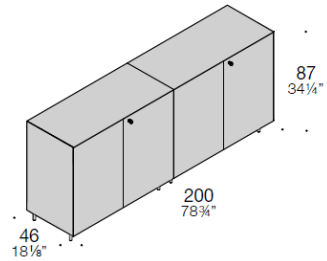

Contenitore L200

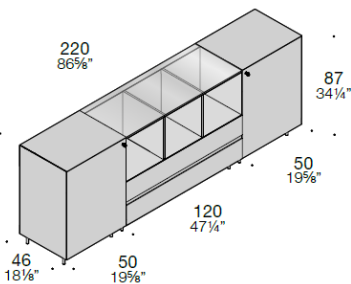

Contenitore L220 (2 moduli L50 + 1 modulo L120)

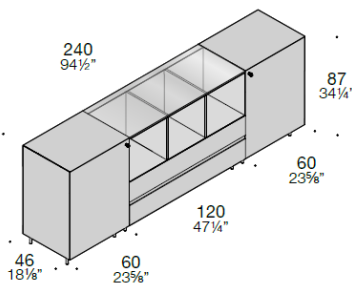

Contenitore L240 (2 moduli L60 + 1 modulo L120)

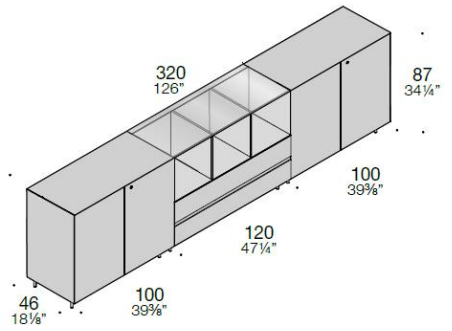

Contenitore L320 (1 modulo L120 + 2 moduli L100)



Contenitore L320 in essenza e mobile di servizio L102 in pelle.



#### HEADQUARTER

Estel Group srl  
Via Santa Rosa 70  
36016 Thiene (VI) – Italy  
Tel. +39 0445 389611  
Fax +39 0445 808801  
[www.estel.com](http://www.estel.com)

Le informazioni riportate si basano  
sugli ultimi listini pubblicati.  
L'Azienda si riserva il diritto di  
apportare modifiche ai prodotti  
senza preavviso.

ESTEL rev. 03\_11/2019

---